

Temperature & Humidity SMS Alarm Controller [GSMS-TH]



Laboratory



Cold Storage



Food Processing



Medical Research



Food Storage



Data Centre



CONTENT

1.	OVERVIEW	3
2.	CONNECTION	5
3.	SCHEMATIC DIAGRAM	6
4.	EXTERNAL TEMPERATURE & HUMIDITY SENSOR	12
5.	INSERTING SIM CARD	14
6.	GSMS-THP SERIES	14
7.	SOLAR POWER CONNECTION [GSMS-THP-XC / SXC]	15
8.	SETUP	16
9.	QUICK STARTUP	17
10.	ALARM TRIGGER RESPONSE TIME	17
11.	GSM NETWORK CONNECTIVITY	17
12.	COMMAND LIST	18
13.	DEAD LOOP PROBLEM	44
14.	POWER LOSS & RESUME	45
15.	SAFETY AND REGULATORY NOTICE	46
16.	MANUFACTURER'S DISCLAIMER STATEMENT	47

1. Overview

a. Introduction

GSMS-TH is designed and integrated with a 16 bit MCU and reliable Siemens GSM module. An external sensor of high accuracy and resolution keeps measuring the "Temperature & Humidity".

It is operated by AC input. Power loss tolerance is secured by its internal rechargeable battery, and low power level alert via SMS.

b. Application

- ⊕ Industrial equipment monitoring, Data Centre, Cold Storage
- ⊕ Food, Medical, Chemical Manufacturing Plant
- ⊕ Rural Monitoring and Security, Environmental Monitoring
- ⊕ Intelligent Factory/Facilities Environmental Control
- ⊕ Large scale area monitoring e.g. Power Plant

c. Features

- ☑ Operates in GSM covering zones, phone alarm dial & SMS alarm message
- ☑ SMS alarm message text programmable, independent for open or close triggered
- ☑ SMS report interval programmable
- ☑ Device Status reporting in Automatic, Schedule or Alarm triggered modes
- ☑ Keep 10 latest SMS alarm message and resend when sending SMS fails
- ☑ Health Status report by GSM mobile phone or PC (RS232)
- ☑ Configuration setup by GSM mobile phone or PC (RS232)
- ☑ Arm/Disarm via SMS command by mobile phone

- ☑ 8 x Alarm Inputs (Opto-isolated)
- ☑ Close or Open triggered alarm
- ☑ Alarm Alert Modes – SMS, Phone Dial or SMS & Phone Dial

- ☑ 2 x AD channels or Temperature and Humidity Sensors
- ☑ Alert High/ Low Levels triggers SMS alarm

- ☑ 3 x Relay Outputs, NC/NO
- ☑ Alarm or SMS activated Relay Control

- ☑ 4 x Mobile/Fixed Phone Number, 2 x Control Centre Phone Number
- ☑ Sound monitoring when microphone is connected
- ☑ Automatic power supply voltage level checking
- ☑ Low Power voltage level alert

d. Safety

- Do not touch the antenna
- GSM 900MHz, 2W max. / GSM 1800MHz, 1W max.
- Not designed for medical equipment or aerospace application

e. Electrical Specification

AC Input Voltage	90~260V AC
Current	500mA (SMS Send/Receive) 20mA (standby)
Peak Pulse Current	< 1A
Operating Temperature	-25° C ~ 65° C
Weight	1.2kg
RS232	9600bps, 8 Data Bits, None Parity, 1 Stop Bit

f. Antenna Requirement

	GSM 900	GSM 1800
RF Frequency	925~960MHz	1805~1880MHz
TX Frequency	880~912MHz	1710~1785MHz
RF Rating	2W 12.5% Loop Loading	1W 12.5% Loop
Loading Resistance	500hm	
Radiation S/N	0dBi	

GSM850/900/1800/1900MHZ is available in US or worldwide Quad Band Version

g. Panels



2. Connection

Front Panel

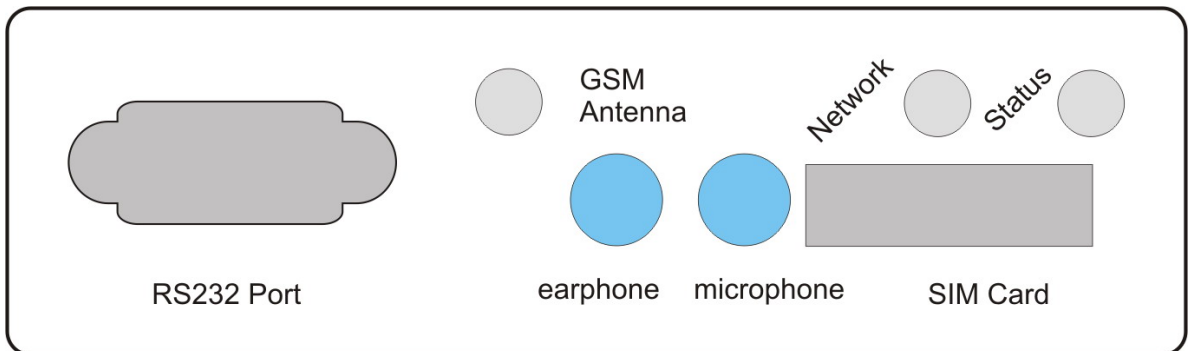

LED1 green [GSM Signal]

Flashing Off > On duration

- * GSM Module Normal Operation

Flashing Same On/Off duration

- * GSM Network Connection Problem

Reason:

- Antenna not connected
- No SIM Card
- Defective SIM Card
- GSM Module Defect

LED2 red [Operation Status]

On

- * Normal

Flash

- * Searching GSM Network
- * Connecting GSM Network
- * Receiving SMS messages
- * Sending SMS messages
- * Phone dialing

2.1 Sound Monitoring

- GSMS-TH automatically picks up any alarm phone call after 8 rings.
- GSMS-TH will reject any call not from alarm phone number.
- By connecting the microphone, mobile phone user can talk to the SMS Messenger.

2.2 PC Connection

- 9600bps, 8bit, No Parity, 1 Stop
- Pin 2 -RXD, Pin 3 - TXD, Pin 5 - GND

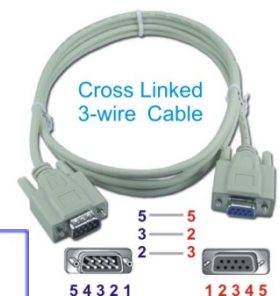
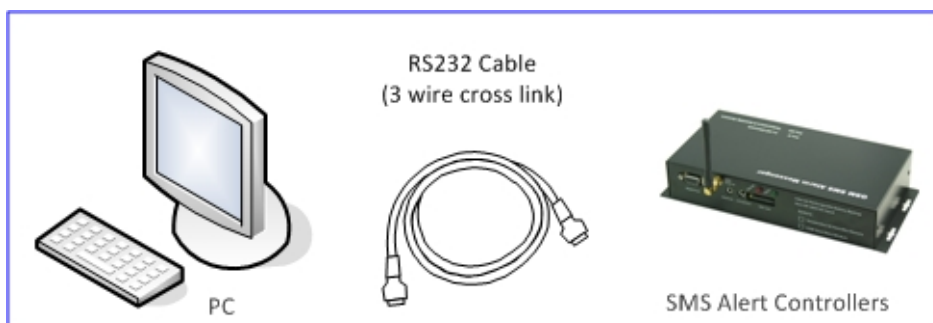

3. Schematic Diagram

3.1 Internal Board

- AC-DC Adaptor (Auto 90~260 VAC)
- Rechargeable Battery: 7.4VDC, 1.2Ah

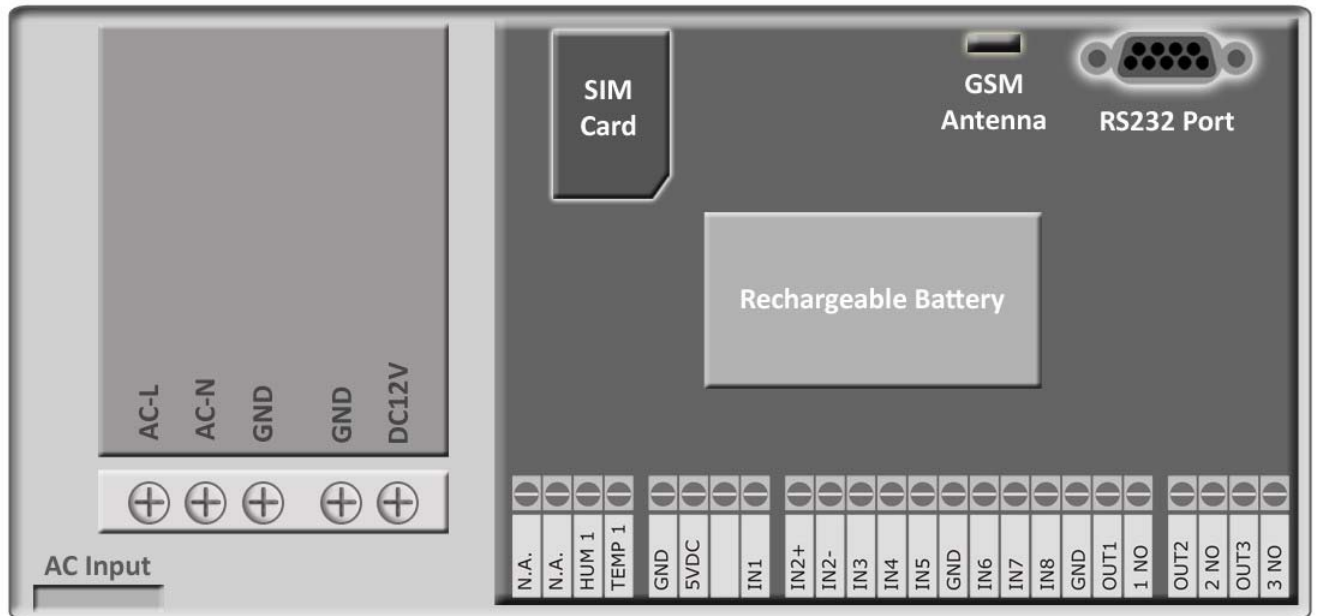

3.2 Internal Rechargeable Battery

- Short the pins BAT-1 and BAT-2 to turn on the rechargeable battery
- When device is not in use, open the pins connection to save the power of rechargeable battery
- When AC power is plugged and BAT pins are shorted, device is powered by AC and internal battery is being charged.
- Charging will be automatically stopped when battery is full.

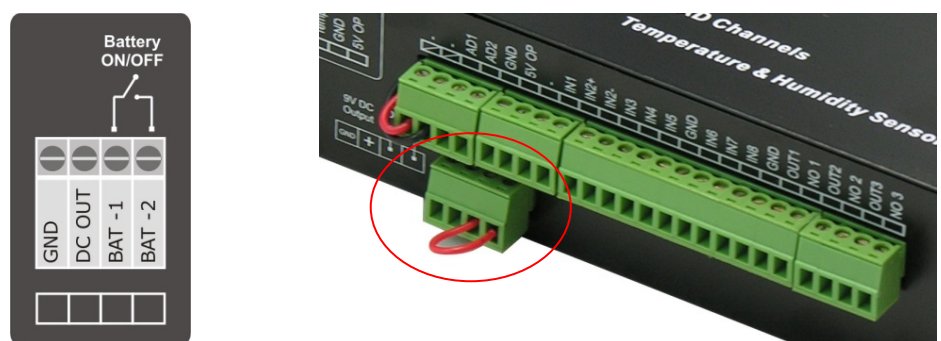

3.3 DC Power Output

- DC output is used to provide the power of alarm input
- All alarm input is power type, but not dry contact

3.4 Model: GSMS-TH-SX

- 1 x Temperature Sensor & 1 x Humidity Sensor Model: TH_V3
- These two inputs should **NOT** be used as normal AD channel inputs

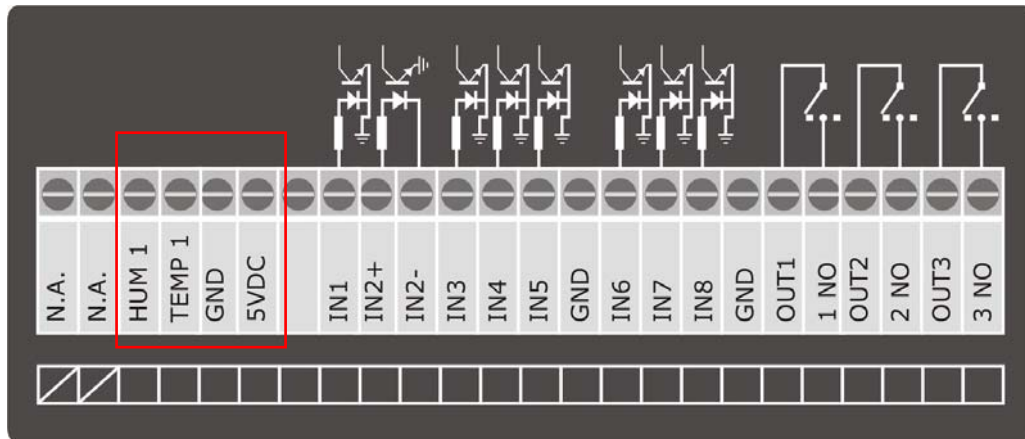

Sensor Cable Color Code:



HUMIDITY

TEMPERATURE

GND

5VDC POWER



3.5 Model: GSMS-TH-ST

- 2 x Temperature Sensors Model: T_V2 or T_V5
- Max. 100 meter sensor cable
- These two inputs should **NOT** be used as normal AD channel or Humidity inputs

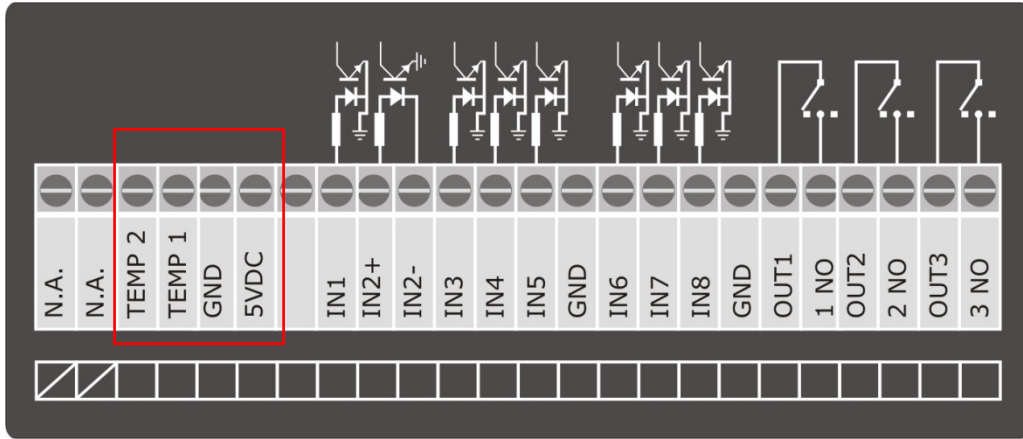

Sensor Cable Color Code:



TEMPERATURE_2

TEMPERATURE_1

GND

5VDC POWER



3.6 Model: GSMS-TH-X

- 2 x AD channels
- Input: DC7~15V, 4 ~ 20mA current type, 250 ohm input impedance

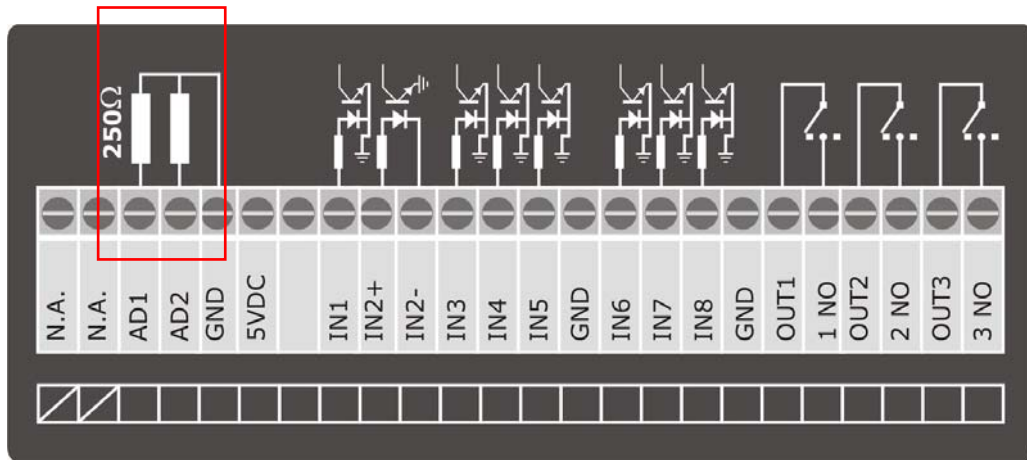

3.7 Model: GSMS-TH-X & Sensors

- Sensor with 4~20mA output
- 2 x AD channels are connected to sensors

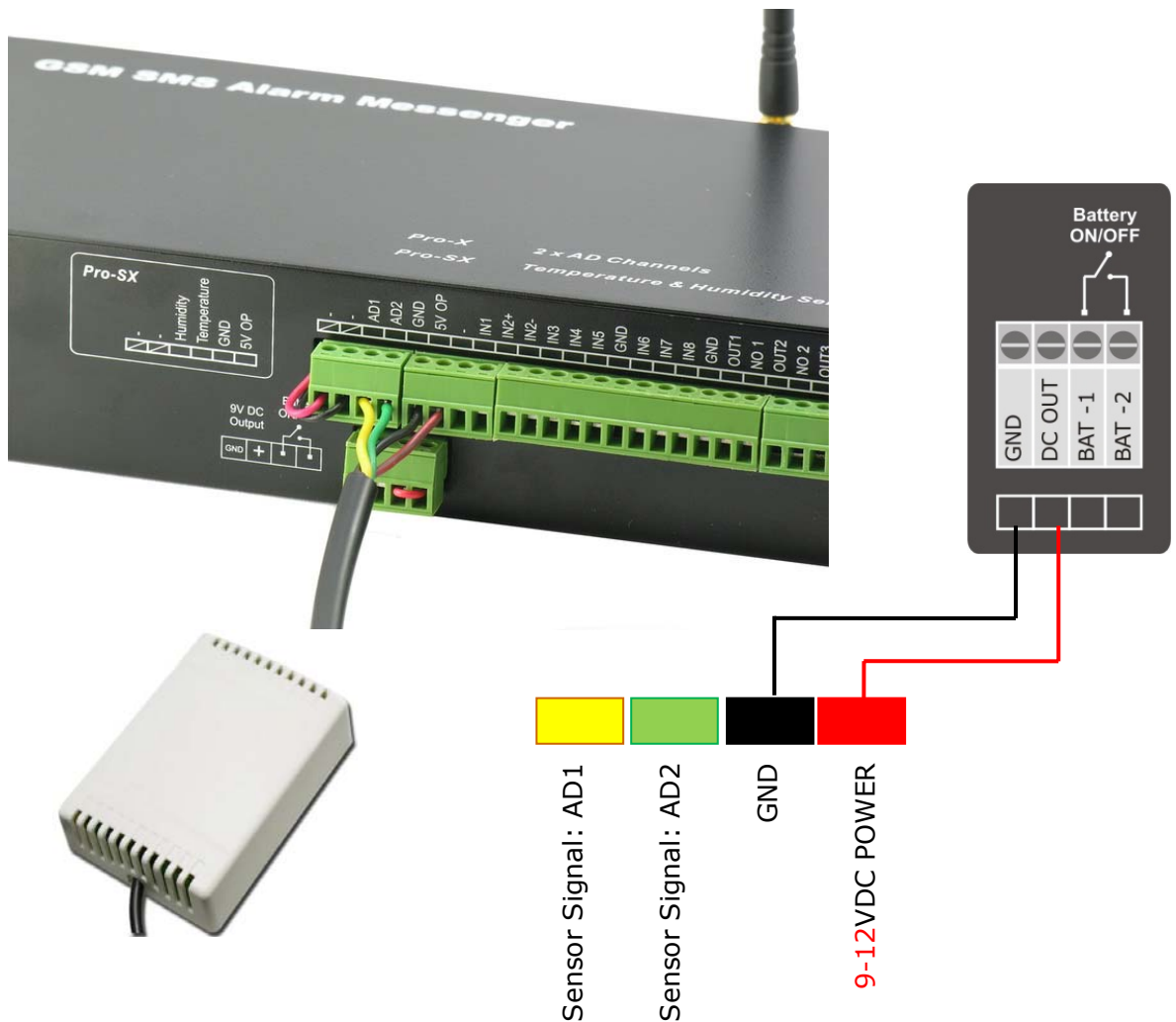

3.8 Alarm Input

- All alarm input is power type, but not dry contact
- Input: 7~12VDC, 7~15mA, 1KΩ Input Resistance
- IN2+, IN2- are independent isolated inputs

[IN2- is **NOT** recommended to be common to the GND of the device]

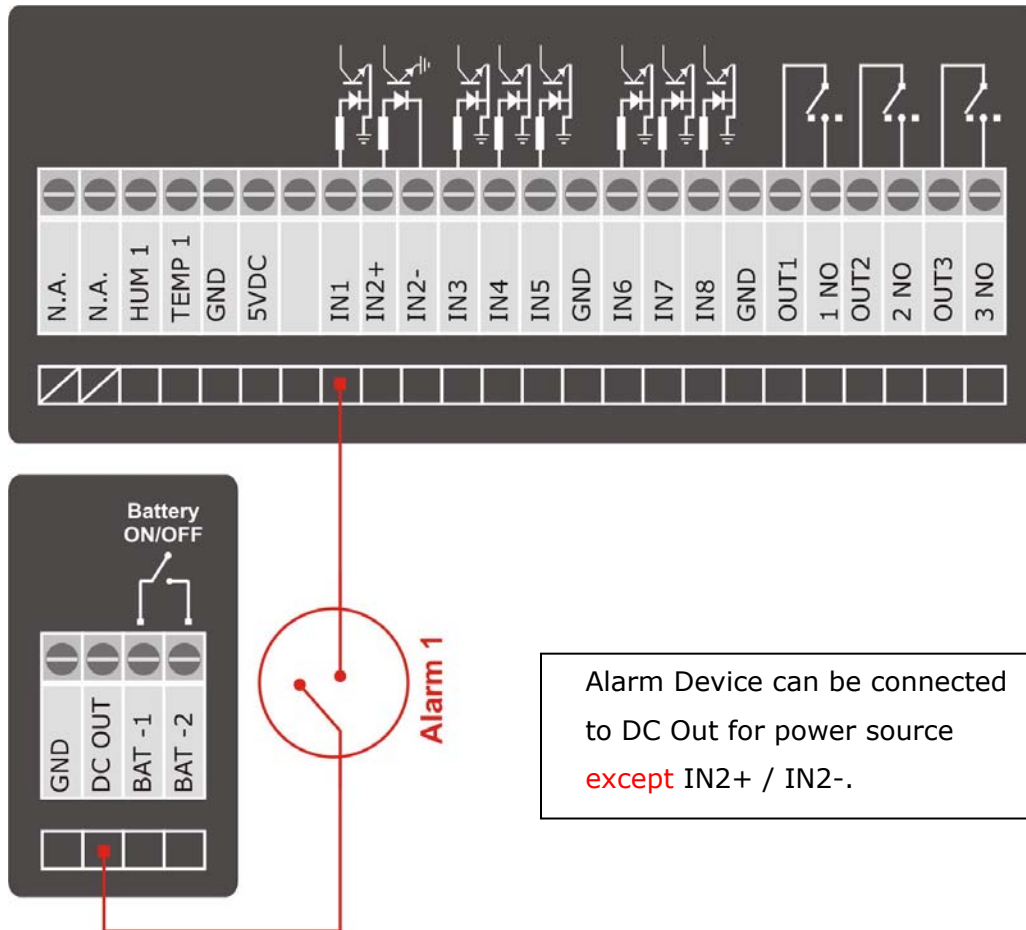

3.9 Relay Output

- Relay Output is dry contact on/off switch
- NC or NO can be set by jumper
- The relay on/off start up status is determined by the jumper setting.
- The relay will resume its start up status when power is off.
- Max. Loading: 3A/30VDC, 3A/220VAC
- OUT1 is used for internal siren

Relay Output jumper		
1	2	3
■	■	■
1-2 Short	Normal Close	
2-3 Short	Normal Open (Default)	

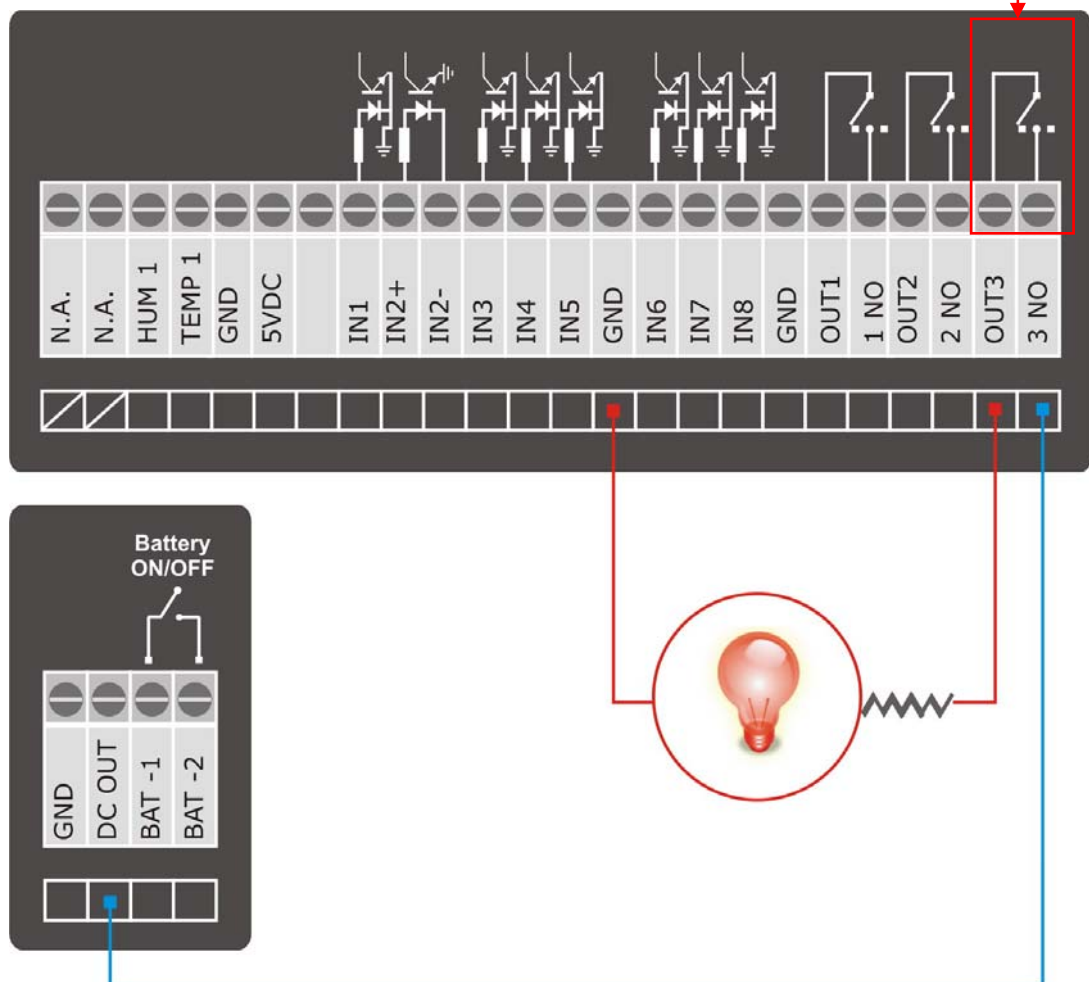

4. External Temperature & Humidity Sensor

4.1) GSMS-THR-SX

External temperature & humidity sensor is supplied with 1m cable. It can be extended up to 10 meter.

Temperature sensor and Humidity Sensor are built in a single enclosure.

External Temperature Sensor

Model: DS18B20
 Temperature Range: -50 ~ 125°C
 Accuracy: 0.1°C
 AD Channel: 2
 High Temperature SMS Alert
 Low Temperature SMS Alert



External Humidity Sensor

Model: CHM-01A
 Humidity Range: 0 ~ 100%RH
 Accuracy: ± 3%RH
 AD Channel: 1
 High Humidity SMS Alert
 Low Humidity SMS Alert



NOTE: Sensor must be installed upwards.

4.2) GSMS-THR-ST

2 x External temperature sensors are supplied with 1m cable. It can be extended up to 100 meter.

Temperature sensor is built in a waterproof steel housing.

External Temperature Sensor

Model: DS18B20
Temperature Range: -50 ~ 125°C
Accuracy: 0.1°C
AD Channel: 1, 2
High Temperature SMS Alert
Low Temperature SMS Alert



5. Inserting SIM card

- 1) Press the yellow button to release the SIM card caddy as shown below.
- 2) Insert the SIM card into caddy.
- 3) Make sure that the golden contact is facing down when inserting the SIM card caddy.



6. GSMS-THP/C series

- 1) IP67 Waterproof Aluminum Case
- 2) High Capacity Battery Built-in
- 3) Solar Panel Controller Built-in



GSMS-THP-X

GSMS-THC-X

7. Solar Power Connection [GSMS-THC-X / SX / ST]

1) Solar Panel Controller

- Solar Panel is connected to the controller as power source
- When solar power is available, it powers device and recharges the 12V battery
- When solar power is not available, battery will powers device
- Press on/off switch shortly to switch different operation modes
- Make sure that digit 6 is displayed on LED for continuous operation mode

2) Connecting to SMS Alarm Messenger

- Connect the controller power output to device

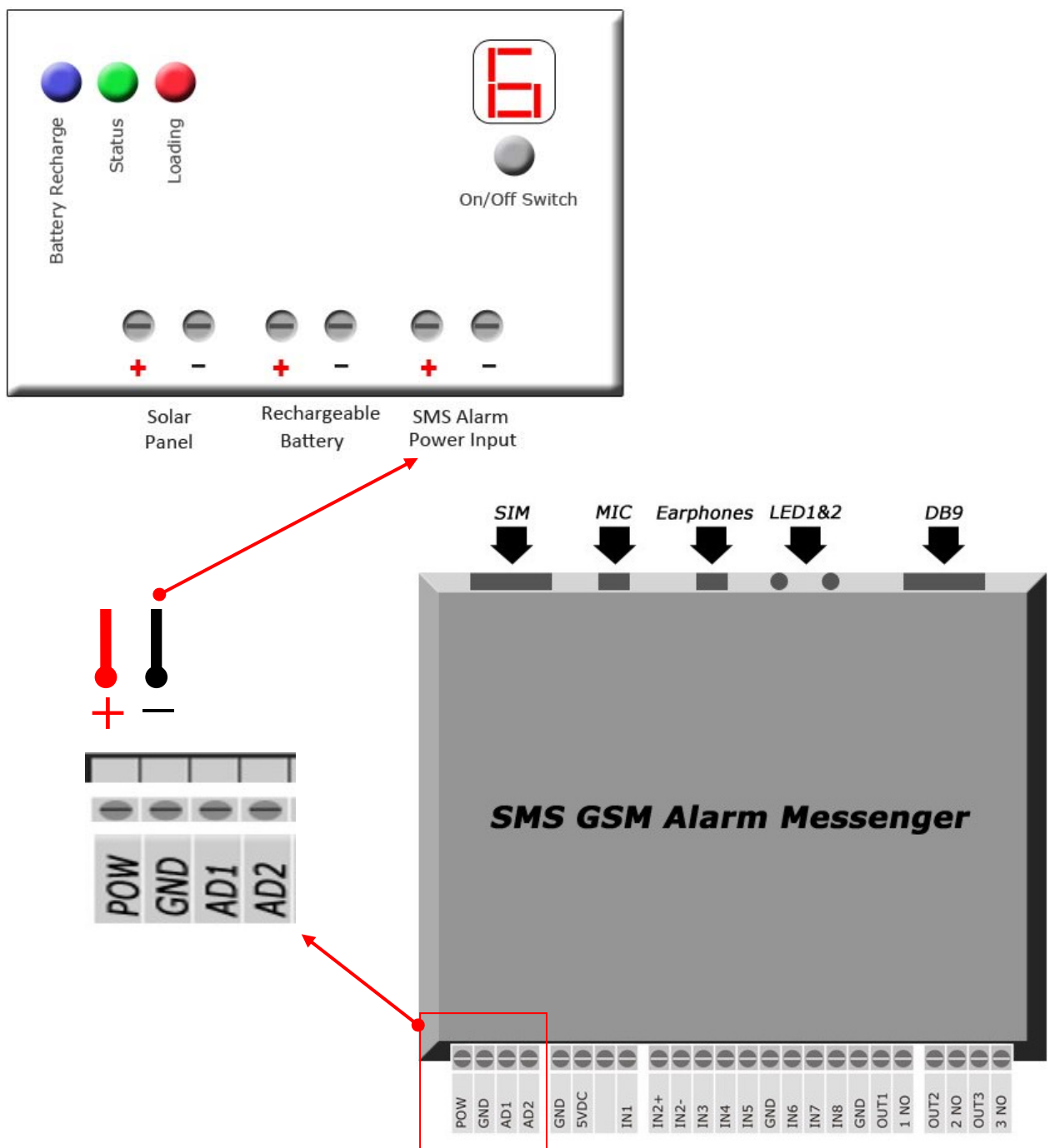

8. Setup

The unit can be programmed remotely or locally by:

(A) SMS command via mobile phone

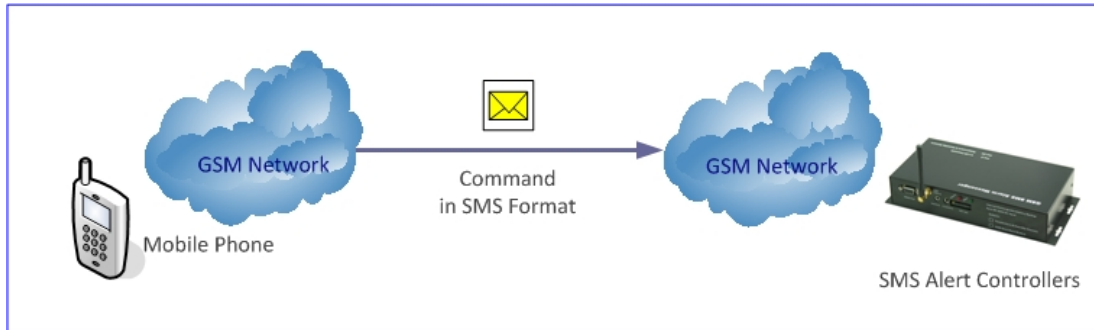

(B) Setup Software via its built-in RS232 port

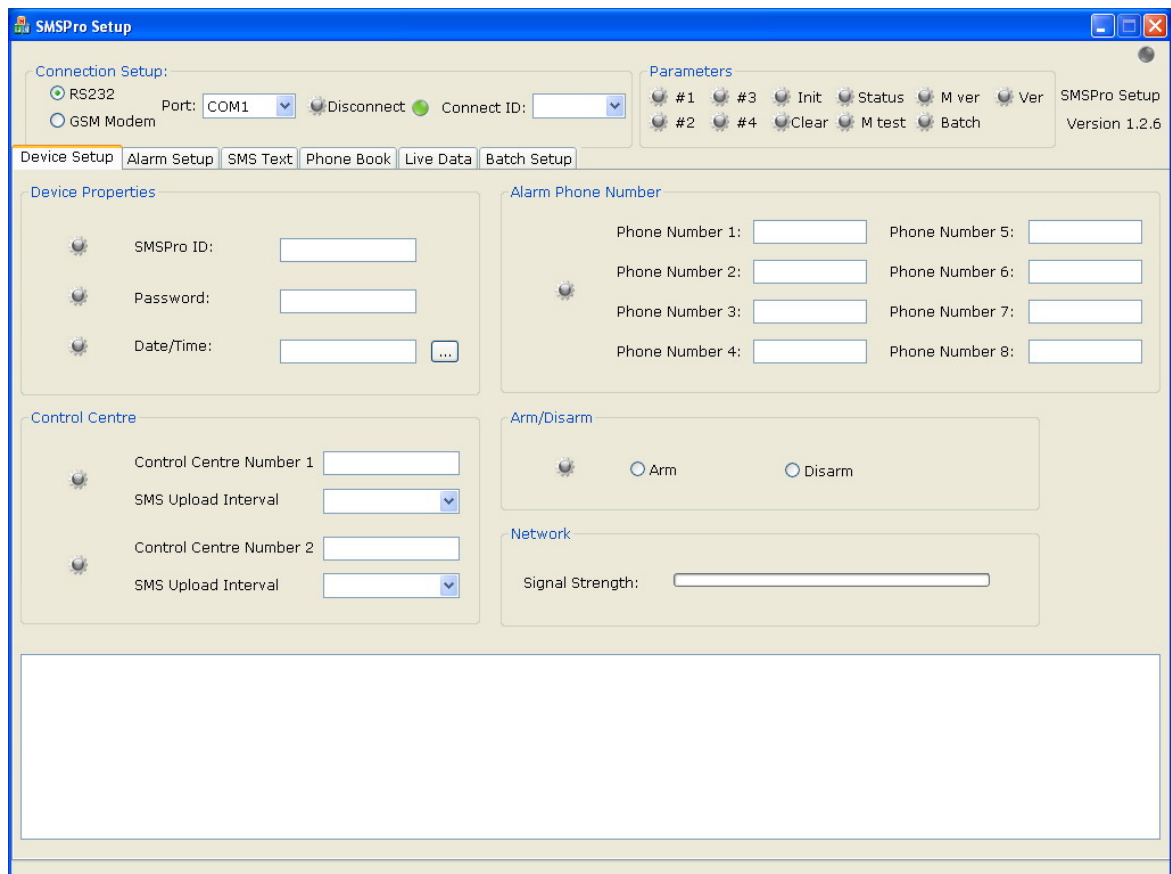
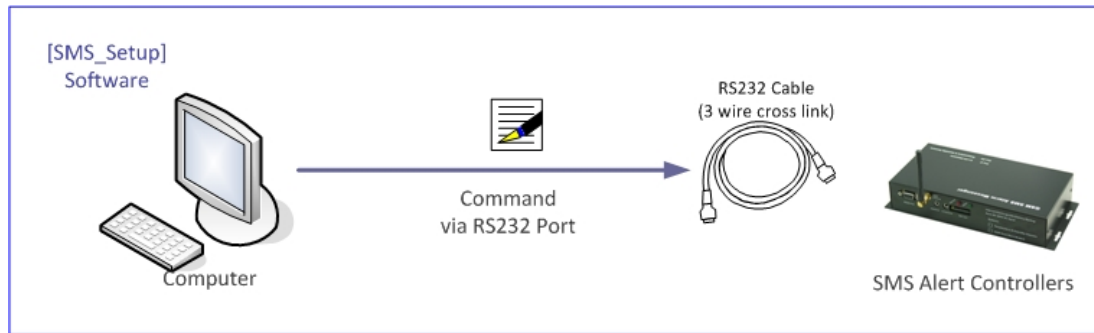

9. Quick Startup

1. Insert SIM Card into the alarm unit
2. Connect 12VDC power input connector, or turn on the switch inside the case
3. Wait until the LED1 is ON, and LED2 flash (OFF > ON duration)
4. Use mobile phone with another SIM card, write a SMS message as below:

PWD:1234,STATUS%

5. Send the message to the phone number of SIM card in the alarm unit
6. Within 30 seconds, your mobile phone will receive a reply SMS message from the alarm unit about its health status.
7. The unit works normally now. Go to the next pages for other operations.

Note: Caller ID service must be activated

10. Alarm Trigger Response Time

After power on, the unit will take about 30 seconds for GSM module initialization and accessing the GSM network.

Upon alarm triggered, the unit will send the SMS alert message to Control Centre, and then other 4 programmable phone numbers. Control Centre can be disabled in order to make the users phone number receiving the alarm sooner.

11. GSM Network Connectivity

1. When GSM network is inaccessible or disconnected on sending SMS, the SMS will be lost.
2. When GSM network is inaccessible or disconnected before sending SMS, the unit will keep searching for the network and send the SMS until the GSM network resumes.
3. When sending the SMS alarm message fails, the SMS unit will keep the last 10 SMS alarm message and resend when the unit succeeds in accessing the GSM network again.

12. Command List

12.1)	NEW PASSWORD SETUP	19
12.2)	MANUAL HEALTH REPORTING	19
12.3)	SERIAL NUMBER SETUP	20
12.4)	CONTROL CENTRE NUMBER & HEALTH REPORTING SCHEDULE SETUP	20
12.5)	POWER UP MESSAGE	21
12.6)	SYSTEM CLOCK SETUP	22
12.7)	PHONE NUMBER SETUP	22
12.8)	ALARM INPUT LEVEL & ALERT SETUP	23
12.9)	SMS ALARM MESSAGE SETUP	25
12.10)	READ THE SMS MESSAGE CONTENT	27
12.11)	USING SMS ALARM MESSENGER TO SEND SMS MESSAGE	28
12.12)	RELAY OUTPUT CONTROL	30
12.13)	RELAY OUTPUT DELAY TIME	30
12.14)	OPERATING VOLTAGE LOW LEVEL ALARM SMS	30
12.15)	INPUT VOLTAGE LOW LEVEL ALARM	31
12.16)	INPUT VOLTAGE ALARM LEVEL SETUP	32
12.17)	ARM/DISARM SETUP	32
12.18)	SYSTEM PARAMETERS RESET	32
12.19)	SYSTEM VERSION CHECK	32
12.20)	RETURN MESSAGE	33
12.21)	DEFAULT SETTING	33
12.22)	SYSTEM PARAMETERS REPORT	34
12.23)	AD PARAMETERS SETUP	37
12.24)	AD CHANNEL ALARM SETUP	38
12.25)	SYSTEM PARAMETERS REPORT (ABOUT AD CHANNELS)	39
12.26)	MANUAL TEMPERATURE CHECK	41
12.27)	TEMPERATURE ALARM SETUP	41
12.28)	MANUAL HUMIDITY CHECK	42
12.29)	HUMIDITY ALARM SETUP	42
12.30)	FINE TUNING OF MEASURING TEMPERATURE & HUMIDITY	43

Command Description

Configure the SMS Alarm Controller by sending the command text through the GSM Mobile Phone, or GSM Modem with Setup Software.

Upon command received and processed, the unit will send a confirmation SMS message back to the mobile phone.

If command is incorrect, the unit will reply "SMS format is error!" to the mobile phone.

12.1) New Password Setup

Command: PWD:XXXX,NEWPWD:YYYY%

XXXX Current Password

YYYY New Password (4 digits)

Example: PWD:1234,NEWPWD:2222%

Default Password: 1234

New Password: 2222

12.2) Manual Health Reporting

Command: PWD:XXXX,STATUS%

[SMS Message received]

ST:XXX;T:2005/01/28/13:00;V:XXXX;AI1:0000;AI2:0000;K1:X;K2:X;K3:X;K4:X;K5:X;K6:X;K7:X;K8:X;OUT1:Y;OUT2:Y;OUT3:Y;#.

Example

ST:002;2005/01/28/13:00;V:8.15;AI1:0000;AI2:0000;K1:1;K2:0;K3:0;K4:1;K5:1;K6:0;K7:0;K8:1;OUT1:1;OUT2:1;OUT3:1;#.

ST	Unit Serial Number	XXX	ASCII code
T	Unit Internal Clock	XXXX	year/month/day/time
V	Operating Voltage	XXXX	
AI1	A/D Channel 1	X	hex digits
AI2	A/D Channel 2	X	hex digits
K1	Alarm Channel 1	K2~8	Alarm Channel 2~8
	K1:0 means "Open"		
	K1:1 means "Closed"		
OUT1	Relay Output 1	OUT2~3	Relay Output 2~3
	OUT1:0 means "Open"		
	OUT1:1 means "Closed"		

12.3) Serial Number Setup**Command:** PWD:XXXX,SN:YYY%

XXXX Password

YYY Serial Number (0-999)

Example: PWD:1234,SN:268%

Password:	1234	(default)
Serial Number Set into the unit:	268	(default: 000)

12.4) Control Centre Number & Health Reporting Schedule Setup

Two values are configured by one single command.

(1) **Control Centre Number** is the phone number receiving the periodic report and regular report. Besides the periodic report on schedule (Command 5), report of any command will be sent to this number in addition to the mobile phone number sending the command. Max. 2 control centre can be defined.

Command: PWD:XXXX,CTRZ:YYYYYYYYYY,MM#%

XXXX Password

Z Control Centre Number (Max. 2 centres)

1 means the first centre number

2 means the second centre number

YYYYYYYYY Phone number in control centre

MM Period Code of Automatic Scheduled Health Report

Example: PWD:1234,CTR1:123456789,05#%

Password: 1234

Report Health Status every 1 hour (refer Table #1)

(2) **Periodic health** status and any command from other mobile phone will be reported to the first control centre with number 123456789.

Table #1 Reference Table for the Automatic Periodic Health Status Report

00	No automatic report	07	Every 6 hours
01	Every 5 minutes	08	Every 12 hours
02	Every 15 minutes	09	Every 1 day (8:00am)
03	Every 30 minutes	10	Every odd day (8:00am)
04	Every 1 hour	11	1 st , 7 th , 14 th , 21 st , 28 th Day (8:00am)
05	Every 2 hours	12	1 st , 15 th Day (8:00am)
06	Every 3 hours	13	1 st Day of Each Month (8:00am)

SMS Pro automatically reports the unit health status on pre-defined schedule via SMS message.

[SMS Message received]

ST:XXX;T:2006/10/08/06:15;V:XXXX;AI1:0000;AI2:0000;K1:X;K2:X;K3:X;K4:X;K5:X;K6:X;K7:X;K8:X;OUT1:1;OUT2:1;OUT3:1;#.

ST	Unit Serial Number	XXX	ASCII code
T	Unit Internal Clock	XXXX	year/month/day/time
V	Operating Voltage	XXXX	
AI1	A/D Channel 1	X	hex digits
AI2	A/D Channel 2	X	hex digits
K1	Alarm Channel 1	K2~8	Alarm Channel 2~8
		K1:0	means "Open"
		K1:1	means "Closed"
OUT1	Relay Output 1	OUT2~3	Relay Output 2~3
		OUT1:0	means "Open"
		OUT1:1	means "Closed"

Example [SMS Message received]:

ST:001;2005/01/27/12:00;V:8.14;AI1:2312;AI2:2131;K1:1;K2:0;K3:0;K4:1;O:1

SMS Unit Current Status

ST	Unit Serial Number	001	
TIME	Unit Internal Clock	Date: 27 Jan 2005	Time: 12:00
V	Operating Voltage	8.14VDC	
AI1	A/D Channel 1	2132	
AI2	A/D Channel 2	X2131	
K1	Alarm Channel 1	1	Closed
K2	Alarm Channel 2	0	Open
K3	Alarm Channel 3	0	Open
K4	Alarm Channel 4	1	Closed
O	Output Relay 1	1	ON

12.5) Power Up Message

Whenever the unit is power up, the unit will automatically send the message "RESTART" to control centre configured in **command 4**.

RESTART!

12.6) System Clock Setup

Command: PWD:XXXX,TIME:AABBCCDDEE%

XXXX Password

AABBCCDDEE Year/Month/Day/Hour/Minute

Example: PWD:1234,TIME:0602031327%

Password: 1234

Clock Set: 3 Feb 2006, 13:27

12.7) Phone Number Setup

4 sets Phone Number (Mobile Phone Number) can be preprogrammed to receive the alarm phone dialing or alarm SMS.

Command: PWD:XXXX,ALMNU1:ZZZZZZZZZZZ,2: ZZZZZZZZZZZZ,
 3: ZZZZZZZZZZZZ,4:ZZZZZZZZZZZZ,5:ZZZZZZZZZZZZ,6:ZZZZZZZZZZZZ,
 7: ZZZZZZZZZZZZ,8:ZZZZZZZZZZZZ#%

XXXX Password

ZZZZZZZZZZZ Phone Number

Example 1:

PWD:1234,ALMNU1:12345678,2:36925814712,3:159357456,4:951753621#%

Password: 1234

Upon Alarm is triggered, call or SMS is made to following numbers.

Number 1 12345678

Number 2 36925814712

Number 3 159357456

Number 4 951753621

Example 2:

PWD:1234,ALMNU1:NUL,3:NUL#%

Password: 1234

Upon first example setup, call to following numbers is cancelled.

Number 1 12345678 Call not made

Number 2 36925814712 Call Retained

Number 3 159357456 Call not made

Number 4 951753621 Call Retained

NUL means no phone number will be set

12.8) Alarm Input Level & Alert Setup

Command: PWD:XXXX,ALMLEVELR:X,YY,ZZZZBBBB,NNN%

XXXX	Password
R	Alarm Channel Number
X	0 means "Disabled" 1 means "Close" triggered alarm 2 means "Open" triggered alarm 3 means both "Close" or "Open" triggered alarm
YY	00 means alarm not report to Control Centre 10 means alarm report to Control Centre 1 01 means alarm report to Control Centre 2 11 means alarm report to Control Centre 1 and 2
ZZZZBBBB	Selection of alarm phone dial and alarm SMS 0 means no alarm report 1 means "SMS" only 2 means "phone dial" only 3 means "SMS" first, and then "phone dial" Z Z Z Z <div style="display: flex; align-items: center;"> <div style="display: flex; flex-direction: column; justify-content: space-around; width: 20px;"> </div> <div style="margin-left: 10px;"> <p>4th phone number</p> <p>3rd phone number</p> <p>2nd phone number</p> <p>1st phone number</p> </div> </div> <div style="display: flex; align-items: center;"> <div style="display: flex; flex-direction: column; justify-content: space-around; width: 20px;"> </div> <div style="margin-left: 10px;"> <p>8th phone number</p> <p>7th phone number</p> <p>6th phone number</p> <p>5th phone number</p> </div> </div>
NNN	Relay Output Control 0 means no relay output control 1 means relay output triggered by alarm N N N <div style="display: flex; align-items: center;"> <div style="display: flex; flex-direction: column; justify-content: space-around; width: 20px;"> </div> <div style="margin-left: 10px;"> <p>3rd Relay Control</p> <p>2nd Relay Control</p> <p>1st Relay Control</p> </div> </div>

Example 1:

PWD:1234,ALMLEVEL2:1,01,10300000,010%

Password: 1234

Alarm Channel 2: Once input is closed, alarm is triggered.

Control Centre 2 will be reported by SMS.

Phone Number 1 SMS alert

Phone Number 2 no report

Phone Number 3 SMS alert, then phone dial

Phone Number 4-8 no report

Relay Output 1 no control

Relay Output 2 triggered "CLOSE" by alarm

Relay Output 3 no control

Example 2:

PWD:1234,ALMLEVEL1:1,11,12300001,100%

Password: 1234

Alarm Channel 1: Once input is closed, alarm is triggered.

Control Centre 1 & 2 will be reported by SMS.

Phone Number 1 SMS alert

Phone Number 2 alarm phone dial

Phone Number 3 SMS alert , then phone dial

Phone Number 4-7 no report

Phone Number 8 SMS alert

Relay Output 1 - triggered "CLOSE" by alarm

Relay Output 2 - no control

Relay Output 3 - no control

Example 3:

How to make the "Relay Output 3" triggered by alarm channels 2 & 5?

Once set, the relay output 3 will no longer be controlled by command 10 "COUT3:1".

Method 1

Enable the control 3 triggered by alarm channels 2 & 5

PWD:1234,ALMLEVEL2:1,11,11110000,001%

PWD:1234,ALMLEVEL5:1,11,11110000,001%

Method 3

Programmed by PC Software "SMDPro" via RS232

Note: Microphone should be connected if "alarm phone dial" is selected.

12.9) SMS Alarm Message Setup

Alarm Channel 1 ~ 8

Command: PWD:XXXX,ALMYTEXT:□□□□□□□□□□#%

XXXX	Password
Y	Alarm Channel Number (1~8)
E	0 Close Triggered Alarm
	1 Open Triggered Alarm

□□□□□□ SMS Message (max. 130 characters)

Example:

PWD:1234,ALM4T1XT:Main Door is Open#%

Alarm Channel 4 is triggered by "Open Contact", SMS Message "Main Door is Open" is sent to the pre-defined mobile phone numbers.

PWD:1234,ALM4T0XT:Main Door is Closed#%

Alarm Channel 4 is triggered by "Close Contact", SMS Message "Main Door is Closed" is sent to the pre-defined mobile phone numbers.

Power Low Level, AD Channel 1 ~ 2

[Low Level Alert Message]

Command: PWD:XXXX,ACL2TEXT:□□□□□□□□□□□#%

- XXXX Password
- Y AD Channel Number (0~2)
 - 0: Low Power Input Voltage Level Alarm
 - 1: AD Channel 1 Alarm
 - 2: AD Channel 2 Alarm
- SMS Message (max. 100 characters)

Example:

PWD:1234,ACL2TEXT:Too Cold Alert#%

Alert Low: 5.250

AD value: 5.123

Password: 1234

Date: 2007-06-12

Time: 19:23

AD value captured is lower than threshold low, so alert SMS is sent with the following message content.

Too Cold Alert >ST:001;TM:28/01/2008,15:45;INPU AD2 ALARM!;A2:5.123.

[High Level Alert Message]

Command: PWD:XXXX,ACH2TEXT:□□□□□□□□□□□#%

- XXXX Password
- Y AD Channel Number (1~2)
 - 1: AD Channel 1 Alarm
 - 2: AD Channel 2 Alarm
- SMS Message (max. 100 characters)

12.10) Read the SMS Message Content

Previous command is used to program the alarm message content into the SMS Alarm Unit.

This command is used to read the message content for verification.

Alarm Channel 1 ~ 8

Command: PWD:XXXX,READYTEXT%

XXXX Password
Y Alarm Channel Number (1~8)

Alarm Message NP: Message for "Close Triggered" alarm
NC: Message for "Open Triggered" alarm

Reply Message: ST001;T:2008/01/22/15/45;NP:□□□□□□□
ST001;T:2008/01/22/15/45;NC:□□□□□□□

This command is used to read the message content for verification.

AD Channel 0 ~ 2

Command: PWD:XXXX,RDACHYTEXT%

XXXX Password
Y AD Channel Number (0~2)
0: Low Power Input Voltage Level Alarm
1: AD Channel 1 Alarm
2: AD Channel 2 Alarm

Command: PWD:XXXX,RDACH2TEXT%

Reply Message: □□□□□>ST001;T:2008/01/22/15/45;INPU AD2 ALARM!;A2:4.200
■■■■■■ >ST001;T:2008/01/22/15/45;INPU AD2 ALARM!;A2:1.300
□□□□□ = alert high alarm message
■■■■■■ = alert low alarm message

Example:

PWD:1234,ACL2TEXT:Alert Low#%

PWD:1234,ACH2TEXT:Alert High#%

Alert High>ST:000;T:08/01/2010,09:29;INPU AD2 ALARM!;A2:00000

Alert Low>ST:000;T:08/01/2010,09:29;INPU AD2 ALARM!;A2:00000

SMS Alarm Unit will reply to the mobile phone with the message content for that alarm channel.

12.11) Using SMS Alarm Messenger to send SMS Message

This command is used to make the SMS Alarm Unit to send the SMS for testing purpose.

Command: **PWD:XXXX,SENDMSA:XB%**

XXXX	Password
A	Phone Number (1~8)
XB	SMS message selection
	00: schedule health check status
	01: Closed Triggered Alarm Channel 1, SMS message
	02: Closed Triggered Alarm Channel 2, SMS message
	03: Closed Triggered Alarm Channel 3, SMS message
	04: Closed Triggered Alarm Channel 4, SMS message
	05: Closed Triggered Alarm Channel 5, SMS message
	06: Closed Triggered Alarm Channel 6, SMS message
	07: Closed Triggered Alarm Channel 7, SMS message
	08: Closed Triggered Alarm Channel 8, SMS message
	09: manual input message
	10: High Voltage Alarm Message [not available]
	11: AD Channel 1, Alert High SMS message
	12: AD Channel 2, Alert High SMS message
	13: Open Triggered Alarm Channel 1, SMS message
	14: Open Triggered Alarm Channel 2, SMS message
	15: Open Triggered Alarm Channel 3, SMS message
	16: Open Triggered Alarm Channel 4, SMS message
	17: Open Triggered Alarm Channel 5, SMS message
	18: Open Triggered Alarm Channel 6, SMS message
	19: Open Triggered Alarm Channel 7, SMS message
	20: Open Triggered Alarm Channel 8, SMS message
	21: Low Voltage Alarm Message
	22: AD Channel 1, Alert Low SMS message
	23: AD Channel 2, Alert Low SMS message

For example: **PWD:1234,SENDMS4:09,Good Morning%**

SMS message "Good Morning" will be sent to the phone number 4.

Error message about setting A:

Number Choice Miss A is not within 1~8

Number Non Exist No phone number is preset in that location

Error message about setting B:

Did not specify SMS contents B is not within 00~20

Reply confirmation message:

Success! SMS Alarm unit succeeds in sending out the message

Failed! Operation failed but phone number exists

When using SMSPro_Setup Software, SMS Alarm Messenger can be used as a GSM Modem sending SMS message to a user alarm mobile phone number.

Please select the following:

- o Select alarm phone number 3, please make sure that this alarm phone number must be preset in device properties first
- o Type the message e.g. "this is a phone test" in Manual Input box
- o Click  button
- o Message "sms alarm" will be sent to the alarm phone 1 as below

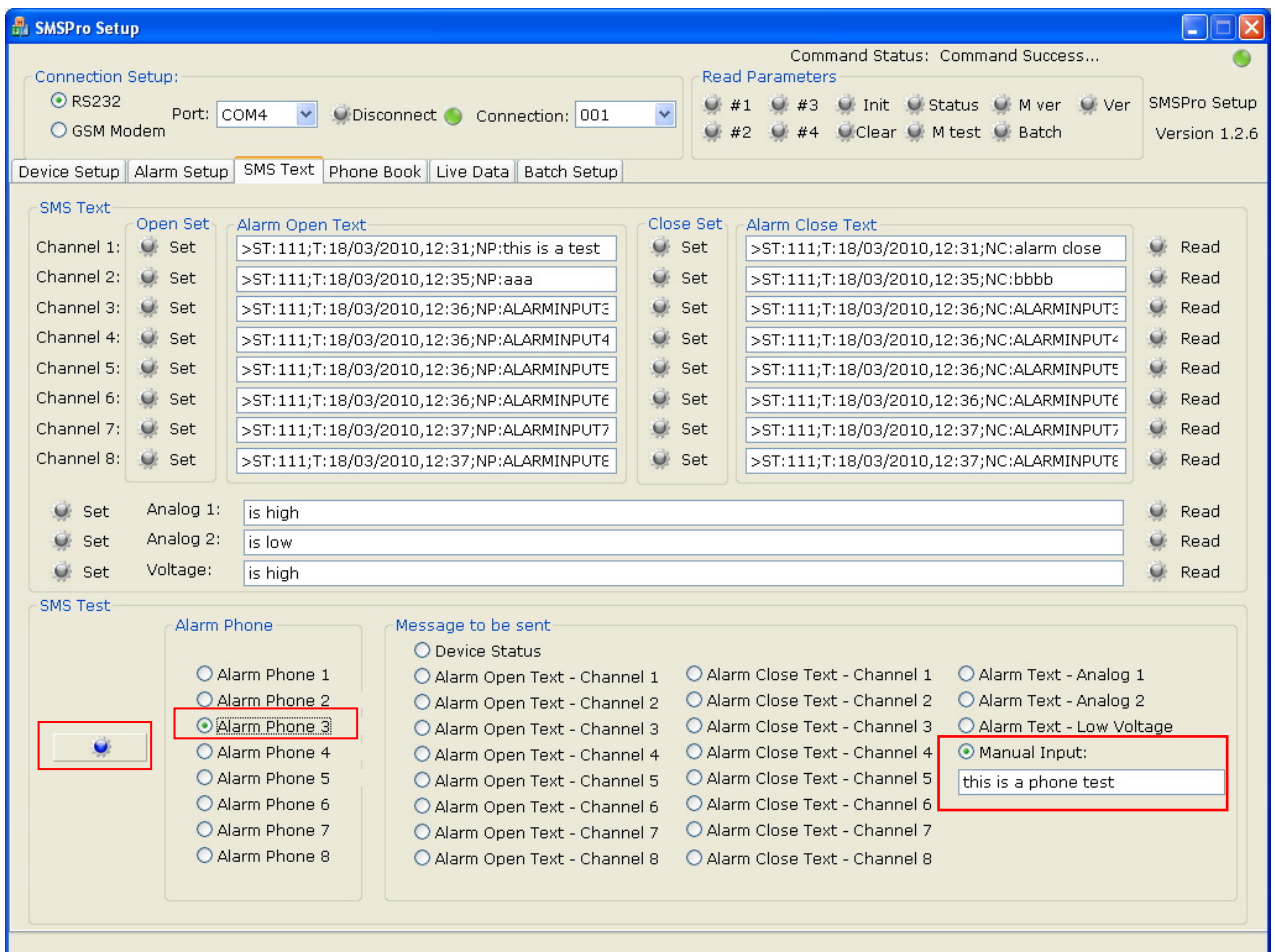

12.12) Relay Output Control**Command: PWD:XXXX,COUTN:Y%**

XXXX	Password
N	Relay Output Channel (1 ~ 3)
Y	1 Turn On (Close) the output
	0 Turn Off (Open) the output

Relay Output is Normally Open by default. The default can be changed by the jumper on the board.

- Command "COUTN:1" is NOT valid when the relay output is triggered by alarm. Reply message will be "ST:XXX" in this case.
- In the above case, command "COUTN:0" is used to reset the relay output after the alarm is triggered.

12.13) Relay Output Delay Time**Command: PWD:XXXX,OUTNDLAY:YYYY%**

XXXX	Password
N	Relay Output Channel (1 ~ 3)
YYYYY	0000 – 9999 seconds
	0000 Turn On or Off the output (default)
	0005 Turn On the output for 5 seconds, and then Off again
	Turn Off the output for 5 seconds, and then On again

Relay output delay time is good for controlling the device e.g. electric door lock/unlock. Only a time lapse on/off is necessary.

12.14) Operating Voltage Low Level Alarm SMS

When the power supply voltage level is below the min. level at 5.34VDC, alert SMS is sent.

Date: 2007-06-15

Time: 13:25

ST:001;TM:200706151325;V:5.34#

12.15) Input Voltage Low Level Alarm

This command is to set the action to be done once the operating voltage drops below the preset value. Value of current operating voltage can be retrieved by the command 2.

Command: PWD:XXXX,ADCOUT:YY,ZZZZBBBB,NNN%

XXXX Password

YY 00 means alarm not report to Control Centre
 10 means alarm report to Control Centre 1
 01 means alarm report to Control Centre 2
 11 means alarm report to Control Centre 1 and 2

ZZZZBBBB Selection of alarm phone dial and alarm SMS
 0 means no alarm report
 1 means "SMS" only
 2 means "phone dial" only
 3 means "SMS" first, and then "phone dial"

Z Z Z Z
 | | | |
 | | | 4th phone number
 | | 3rd phone number
 | 2nd phone number
 1st phone number

B B B B
 | | | |
 | | | 8th phone number
 | | 7th phone number
 | 6th phone number
 5th phone number

NNN Relay Output Control
 0 means no relay output control
 1 means relay output triggered by alarm

N N N
 | | |
 | | 3rd Relay Control
 | 2nd Relay Control
 1st Relay Control

12.16) Input Voltage Alarm Level Setup**Command:** PWD:XXXX,POWVL:mmmm%

XXXX Password

mmmm when power input is lower than this value, alarm is triggered

Example: PWD:1234,POWVL:8.25%

Password: 1234

When the battery voltage is lower than 8.25VDC, alarm is triggered.

The reactive will be setup by the command above.

12.17) Arm/Disarm Setup**Command:** PWD:XXXX,ARM%

XXXX Password

Example: PWD:1234,ARM%

Password: 1234

Unit is armed, and in alert status

Command: PWD:XXXX,DISARM%

XXXX Password

Example: PWD:1234,DISARM%

Password: 1234

Unit is disarmed, and no alarm is reported

12.18) System Parameters RESET**PWD:XXXX,PARAMETER&%**

This is to reset the parameters and password into default setting.

[SMS Message received]

Parameter initialize success!

12.19) System Version Check**PWD:XXXX,CHECKVR%**

[SMS Message received]

SD41 V7.2_3_B 2010/01/28

12.20) Return Message

Command succeeds

SMS Message: Function Code & Setting Parameters Set in the command

Command fails

SMS Message: SMS format is error!

12.21) Default Setting

PWD:1234,PARAMETER1%

ST:000;T:2006/10/01/01:01;H:1;F1:,00;F2:,00;XH:31#

PWD:1234,PARAMETER2%

ST:000:VL:7.00,O:00,0000,000;A1M:5.000,0.000,1.000,0,5.000,0.500,O:00,00000000,000;A2M:5.000,0.000,1.000,0,5.000,0.000,O:00,00000000,000#

PWD:1234,PARAMETER3%

ST:000;K1:1,O:00,00000000,000;K2:1,O:00,00000000,000;K3:1,O:00,00000000,000;K4:1,O:00,00000000,000;K5:1,O:00,00000000,000;K6:1,O:00,00000000,000;K7:1,O:00,00000000,000;K8:1,O:00,00000000,000;OTY:0000,0000,000;#

PWD:1234,PARAMETER4%

ST:000; C1:,1;C2:,1;C3:,1;C4:,1; C5:,1; C6:,1; C7:,1; C8:,1;#

12.22) System Parameters Report

PWD:XXXX,PARAMETER1%

[SMS Message received]

ST:XXX;T:2006/10/08/08:00;H:X;F1:XXXXXXXXXX,YY;F2:XXXXXXXXXX,YY;
XH:RR;ER:xyz#

ST:	XXX	Unit Serial Number	
T:	2006/10/08/08:00	Date/Time	
H:	X	1	Arm
		0	Disarm
F1:	1 st Control Centre Number		
	XXXXXXXXXX	Control Centre Phone Number	
	YY	Automatic Health Report Schedule	
F1:	2 nd Control Centre Number		
C1	1 st Alarm Phone Number		
	XXXXXXXXXX	Alarm Phone Number	
	Y	1	Alarm Report enabled
		0	Alarm Report disabled
XH:RR	GSM Network Signal Strength (1 ~ 40)		
ER: xyz		Normal	Defect
	GSM Module	x: 0	1
	SIM Card/Service	y: 0	1
	GSM Network Coverage	z: 0	1

PWD:XXXX,PARAMETER4%

ST:XXX;C1:XXXXXXXXXX,Y;C2:XXXXXXXXXX,Y;C3:XXXXXXXXXX,Y;C4:XXXXXX
XXXX,Y;C5:XXXXXXXXXX,Y;C6:XXXXXXXXXX,Y;C7:XXXXXXXXXX,Y;
C8:XXXXXXXXXX,Y;#

C2 ~ C8 2nd ~ 8th Alarm Phone Number

PWD:XXXX,PARAMETER2%

[SMS Message received]

ST:XXX;VL:XXXX,O:AX,BBBBBBBB,CCC;A1M:XXXXX,UUUUU,YYYYY,R,HHHHH,PPPPP,O:AX,BBBBBBBB,CCC;A2M:XXXXX,UUUUU,YYYYY,R,HHHHH,PPPPP,O:AX,BBBBBBBB,CCC;#

VL	Min. Operating Voltage, below this level will trigger alarm 7VDC by default	
A	alarm report to Control Centre 1	0 means no report 1 means report
X	alarm report to Control Centre 2	0 means no report 1 means report
BBBBBBBB	report status for 8 phone numbers	0 means no report 1 means "SMS" but no "phone dialing" 2 means "phone dialing" but no "SMS" 3 means "SMS" and then "phone dialing"
CCC	relay output control	0 means relay is not controlled by low voltage alarm 1 means relay is turned on by low voltage alarm

PWD:XXXX,PARAMETER3%

ST:XXX;K1:N,O:AX,BBBBBBBB,CCC;K2:N,O:AX,BBBBBBBB,CCC;K3:N,O:AX,BBBBBBBB,CCC;K4:N,O:AX,BBBBBBBB,CCC;K5:N,O:AX,BBBBBBBB,CCC;K6:N,O:AX,BBBBBBBB,CCC;K7:N,O:AX,BBBBBBBB,CCC;K8:N,O:AX,BBBBBBBB,CCC;OTY:0000,0000,0000;#

Message is longer than 160 bytes.

By SMS, two separate messages will be sent via GSM.

By RS232 port, one message will be uploaded to PC.

Alarm 1 ~ 8 Status Report

K1	Alarm Channel 1	
N	0 means "Disabled"	
	1 means "Close" triggered alarm	
	2 means "Open" triggered alarm	
	3 means both "Close" or "Open" triggered alarm	
O	Control Centre Report Setting	
A	alarm report to Control Centre 1	0 means no report 1 means report
X	alarm report to Control Centre 2	0 means no report 1 means report
BBBBBBBB	report status for 8 phone numbers	
	0 means no report	
	1 means "SMS" but no "phone dialing"	
	2 means "phone dialing" but no "SMS"	
	3 means "SMS" and then "phone dialing"	
CCC	relay output control	
	0 means control not triggered by alarm	
	1 means alarm triggered control	
OTY	0000	1 st relay time lapse
	0000	2 nd relay time lapse
	0000	3 rd relay time lapse

COMMAND (Analog to Digital Channel)**12.23) AD Parameters Setup**

PWD:XXXX,ADVALEB:UUUUU,XXXXX,NNNNN,Y,ZZZZZ,WWWWW%

B	Channel 1 or 2
UUUUU	Measuring Range Upper Limit
XXXXX	Measuring Range Lower Limit
NNNNN	Start Value
Y	0: AD Alarm disabled
	1: AD Alarm enabled, Relay On Time Lapse
	2: AD alarm enabled, Relay On when AD is higher than Alert High Relay Off when AD resumes normal
	3: AD alarm enabled, Relay On when AD is lower than Alert Low Relay Off when AD resumes normal
	4: AD alarm enabled, Relay On when AD is beyond Alert High & Low Relay Off when AD is within Alert High & Low
ZZZZZ	Alert High Value Setup
WWWWW	Alert Low Value Setup

Operation in case Y=1:

- When the captured analog value is higher or lower than the alert values, alarm is triggered.
- SMS or Dial Phone etc corresponding actions described on next page will be taken.
- Relay is turn on, and off after preset time lapse.
- Alarm will only be re-triggered when the captured analog value returns to normal range and then reaches beyond the alert values again.

Operation in case Y=4:

- When the captured analog value is higher or lower than the alert values, alarm is triggered.
- SMS or Dial Phone etc corresponding actions described on next page will be taken.
- Relay is turn on, and only off when analog value is back within Alert Range.
- Alarm will only be re-triggered when the captured analog value returns to normal range and then goes beyond the alert values again.

Application:

- When temperature is high, ventilation fan is turn on to cool down.
- When temperature is normal again, ventilation fan is turn off to save power.

12.24) AD Channel Alarm Setup

PWD:XXXX,ADCOUTB:YY,ZZZZBBBB,NNN%

XXXX	Password																																								
B	0: Low Voltage Alarm 1: AD Channel 1 Alarm 2: AD Channel 2 Alarm																																								
YY	00 means alarm not report to Control Centre 10 means alarm report to Control Centre 1 01 means alarm report to Control Centre 2 11 means alarm report to Control Centre 1 and 2																																								
ZZZZBBBB	Selection of alarm phone dial and alarm SMS 0 means no alarm report 1 means "SMS" only 2 means "phone dial" only 3 means "SMS" first, and then "phone dial" Z Z Z Z <table border="0" style="margin-left: 20px;"> <tr> <td style="border-left: 1px solid black; height: 40px; width: 10px;"></td> <td style="border-left: 1px solid black; height: 40px; width: 10px;"></td> <td style="border-left: 1px solid black; height: 40px; width: 10px;"></td> <td style="border-left: 1px solid black; height: 40px; width: 10px;"></td> <td style="padding-left: 10px;">4th phone number</td> </tr> <tr> <td style="border-left: 1px solid black; height: 20px;"></td> <td style="border-left: 1px solid black; height: 20px;"></td> <td style="border-left: 1px solid black; height: 20px;"></td> <td style="border-left: 1px solid black; height: 20px;"></td> <td style="padding-left: 10px;">3rd phone number</td> </tr> <tr> <td style="border-left: 1px solid black; height: 20px;"></td> <td style="border-left: 1px solid black; height: 20px;"></td> <td style="border-left: 1px solid black; height: 20px;"></td> <td style="border-left: 1px solid black; height: 20px;"></td> <td style="padding-left: 10px;">2nd phone number</td> </tr> <tr> <td style="border-left: 1px solid black; height: 20px;"></td> <td style="border-left: 1px solid black; height: 20px;"></td> <td style="border-left: 1px solid black; height: 20px;"></td> <td style="border-left: 1px solid black; height: 20px;"></td> <td style="padding-left: 10px;">1st phone number</td> </tr> </table> <table border="0" style="margin-left: 20px;"> <tr> <td style="border-left: 1px solid black; height: 40px; width: 10px;"></td> <td style="border-left: 1px solid black; height: 40px; width: 10px;"></td> <td style="border-left: 1px solid black; height: 40px; width: 10px;"></td> <td style="border-left: 1px solid black; height: 40px; width: 10px;"></td> <td style="padding-left: 10px;">8th phone number</td> </tr> <tr> <td style="border-left: 1px solid black; height: 20px;"></td> <td style="border-left: 1px solid black; height: 20px;"></td> <td style="border-left: 1px solid black; height: 20px;"></td> <td style="border-left: 1px solid black; height: 20px;"></td> <td style="padding-left: 10px;">7th phone number</td> </tr> <tr> <td style="border-left: 1px solid black; height: 20px;"></td> <td style="border-left: 1px solid black; height: 20px;"></td> <td style="border-left: 1px solid black; height: 20px;"></td> <td style="border-left: 1px solid black; height: 20px;"></td> <td style="padding-left: 10px;">6th phone number</td> </tr> <tr> <td style="border-left: 1px solid black; height: 20px;"></td> <td style="border-left: 1px solid black; height: 20px;"></td> <td style="border-left: 1px solid black; height: 20px;"></td> <td style="border-left: 1px solid black; height: 20px;"></td> <td style="padding-left: 10px;">5th phone number</td> </tr> </table>					4 th phone number					3 rd phone number					2 nd phone number					1 st phone number					8 th phone number					7 th phone number					6 th phone number					5 th phone number
				4 th phone number																																					
				3 rd phone number																																					
				2 nd phone number																																					
				1 st phone number																																					
				8 th phone number																																					
				7 th phone number																																					
				6 th phone number																																					
				5 th phone number																																					
NNN	Relay Output Control 0 means no relay output control 1 means relay output triggered by alarm N N N <table border="0" style="margin-left: 20px;"> <tr> <td style="border-left: 1px solid black; height: 40px; width: 10px;"></td> <td style="border-left: 1px solid black; height: 40px; width: 10px;"></td> <td style="border-left: 1px solid black; height: 40px; width: 10px;"></td> <td style="padding-left: 10px;">3rd Relay Control</td> </tr> <tr> <td style="border-left: 1px solid black; height: 20px;"></td> <td style="border-left: 1px solid black; height: 20px;"></td> <td style="border-left: 1px solid black; height: 20px;"></td> <td style="padding-left: 10px;">2nd Relay Control</td> </tr> <tr> <td style="border-left: 1px solid black; height: 20px;"></td> <td style="border-left: 1px solid black; height: 20px;"></td> <td style="border-left: 1px solid black; height: 20px;"></td> <td style="padding-left: 10px;">1st Relay Control</td> </tr> </table>				3 rd Relay Control				2 nd Relay Control				1 st Relay Control																												
			3 rd Relay Control																																						
			2 nd Relay Control																																						
			1 st Relay Control																																						

12.25) System Parameters Report (about AD channels)

PWD:XXXX,PARAMETER2%

[SMS Message received]

ST:XXX;VL:XXXXX,O:AX,BBBB,CCC;A1M:XXXXX,UUUUU,YYYYY,R,HHHHH,PPPPP,O:AX,
BBBBBBBB,CCC;A2M:XXXXX,UUUUU,YYYYY,R,HHHHH,PPPPP,O:AX,BBBBBBBB,CCC;#

A1	AD Channel 1	
M:	XXXXX	Range Upper Limit
	UUUUU	Range Lower Limit
	YYYYY	Start Value
R	1	AD Channel Alarm enabled
	0	AD Channel Alarm disabled
HHHHH		Alarm Triggered Alert High Value
PPPPP		Alarm Triggered Alert Low Value
O:	A	alarm report to Control Centre 1
		0 means no report
		1 means report
	X	alarm report to Control Centre 2
		0 means no report
		1 means report
BBBBBBBB		report status for 8 phone numbers
		0 means no report
		1 means "SMS" but no "phone dialing"
		2 means "phone dialing" but no "SMS"
		3 means "SMS" and then "phone dialing"
CCC		relay output control
		0 means relay is not controlled by alarm
		1 means relay is turned on by alarm
A2M...	AD Channel 2	

Note: AI1 and AI2 values are reported by COMMAND [PWD:XXXX,STATUS%]

Example:

A1M:0.600,0.000,1.000,1,0.500,0.100

0.600	range upper limit
0.000	range lower limit
1.000	Start Value is "1.000" (4mA * 250Ω=1)
1	Alarm Enabled
0.500	Threshold High
0.100	Threshold Low

Standard range of data captured in AD Channel 1 is 4~20mA.

AI1 value depends on user setting of "Range", "Start Value" and the input current "c".

Start Value = 4mA x 250Ω = 1

AD Range = 0.600 - 0.000 usually specified by the current type transducer

$$AI1 = \frac{(c \times 250 - \text{Start Value})}{(0.02 \times 250 - \text{Start Value})} \times \text{Range}$$

AI1 reported value will be = Range x (0.012 x 250 - Start Value) / (5 - Start Value)

When current input is 12mA, AI1 = 0.6 x (0.012 x 250 - 1) / (5 - 1) = 0.3

When user requires:

High level alarm at 0.018mA

Low level alarm at 0.008mA

H = (0.018 x 250 - 1) x 0.6 / (0.02 x 250 - 1) = 0.525

L = (0.008 x 250 - 1) x 0.6 / (0.02 x 250 - 1) = 0.15

When AI1 value is over 0.525 or below 0.150, alarm will be triggered – SMS alert message will be sent out to phone number 1 and relay 1 is turned on.

Command: PWD:1234,ADVALE1:0.600,0.000,1.000,1,0.525,0.150%

Command: PWD:1234,ADCOUT1:10,10000000,100%

External Temperature Sensor Operation

- AD Channel 2 is used for temperature measurement
- AD Channel 1 is used for humidity measurement [GSMS-THR-SX]
- AD Channel 1 is used for temperature measurement [GSMS-THR-ST]

12.26) Manual Temperature Check

Command: PWD:XXXX,STATUS%

[SMS Message received]

ST:XXX;T:2005/01/28/13:00;V:XXXX;AI1:0000;AI2:0000;K1:X;K2:X;K3:X;K4:X;K5:X;K6:X;K7:X;K8:X;OUT1:Y;OUT2:Y;OUT3:Y;#.

AI2	Current Temperature	[GSMS-THR-SX]
AI1, AI2	Current Temperatures	[GSMS-THR-ST]

12.27) Temperature Alarm Setup

PWD:XXXX,ADVALE2:UUUUU,XXXXX,NNNNN,Y,ZZZZZ,WWWWW%

2	AD Channel 2		
UUUUU	Range Upper Limit	0.000	Default
XXXXX	Range Lower Limit	250.0	Default
NNNNN	Start Value	000.0	Default
Y	1: Triggered Alarm enabled 0: Triggered Alarm disabled		
ZZZZZ	Alert High Temperature Setup		
WWWWW	Alert Low Temperature Setup		

Example:

When temperature is above 70° or below 15°, SMS alarm message will be sent to phone number 3 and relay output 1 will be triggered.

AD Channel	2
Range High/Low, Start Value	Ignored
Triggered Alarm enabled	1
Alert High Temperature Setup	070.0
Alert Low Temperature Setup	015.0

PWD:1234,ADVALE2:250.0,0.000,000.0,1,070.0,015.0%

PWD:1234,ADCOU2:00,00100000,100%

External Humidity Sensor Operation

- AD Channel 2 is used for temperature measurement
- AD Channel 1 is used for humidity measurement [GSMS-THR-SX]

12.28) Manual Humidity Check

Command: PWD:XXXX,STATUS%

[SMS Message received]

ST:XXX;T:2005/01/28/13:00;V:XXXX;AI1:0000;AI2:0000;K1:X;K2:X;K3:X;K4:X;K5:X;K6:X;K7:X;K8:X;OUT1:Y;OUT2:Y;OUT3:Y;#.

AI1 Current Humidity

12.29) Humidity Alarm Setup

PWD:XXXX,ADVALE1:UUUUU,XXXXX,NNNNN,Y,ZZZZZ,WWWWW%

1	AD Channel 1		
UUUUU	Range Upper Limit	140.0	
XXXXX	Range Lower Limit	0.000	
NNNNN	Start Value	000.0	Default
Y	1: Triggered Alarm enabled		
	0: Triggered Alarm disabled		
ZZZZZ	Alert High Humidity Setup		
WWWWW	Alert Low Humidity Setup		

Example:

When humidity is above 70%RH or below 15%RH, SMS alarm message will be sent to phone number 2 and relay output 3 will be triggered.

AD Channel	1
Measuring Range	140.0 – 0.000
Start Value	000.0
Triggered Alarm enabled	1
Threshold High Humidity Setup	070.0
Threshold Low Humidity Setup	015.0

PWD:1234,ADVALE2:140.0,000.0,1,070.0,015.0%

PWD:1234,ADCOUT1:00,01000000,001%

External Temperature Sensor Specification:

Model:	DS18B20		
Power Input:	5VDC		
Measuring Range:	-50 ~ 125°C		
Output Signal:	Digital Signal		
AD2 Channel Setup	Start Value:	000.0	Default
	Range:	250.0	Default

External Humidity Sensor Specification:

Model:	CHM-01A (Resistance Type Humidity Sensor)		
Power Input:	5V±5%		
Power Rating:	5mA max.(2mA avg.)		
Operating Range:	Temperature	0~60°C	
	Humidity	10% -- 95%RH	
Measuring Range:	0~100%RH		
Temperature Factor:	0.4%RH/°C		
	30~80%RH @5V Operating Voltage		
	Temperature Range=10~40°C (reference point: 25°C)		
Accuracy:	±5%RH (at 25, Input 5V)		

12.30) Fine Tuning of Measuring Temperature & Humidity

Temperature sensor is digital type. No calibration is necessary.

Humidity sensor needs calibration.

Output Signal:	0~3 DCV		
	0VDC = 0RH		
	3VDC = 100RH		
AD1 Channel Setup	Start Value:	000.0	Default
	Range:	140.0	Default

Adjust the Range of AD1 Channel Setup from 100 ~ 150 for calibration.

- ❗ "SMSPRo_Setup" Software provides a one-click button operation of calibration. Please refer to the manual of Setup Software.

13. Dead Loop Problem

Please find below the possible cause of the "dead loop" problem which creates thousands of SMS delivery. User must pay attention to the setup of phone numbers.



A SMS Alarm Messenger – Unit A
SIM Card Phone Number: 12345678

⊗ Either "One of alarm phone number" or "Control Centre Phone Number": 33333333



B SMS Alarm Messenger – Unit B
SIM Card Phone Number: 33333333

1. When [Unit A] alarm is triggered, it will send alarm message to alarm phone number or control centre phone number.
2. When "alarm phone number" or "control centre phone number" is set to the phone number of another SMS Alarm Unit [Unit B], "Dead Loop" problem happens.
3. [Unit B] receives the alarm message from [Unit A]. Since it will consider this incoming text as a wrong command message, [Unit B] will reply to [Unit A] a message "SMS format is error!".
4. Then, [Unit A] receives the message "SMS format is error!" from [Unit B], it also considers this incoming text as a wrong command message. Therefore, [Unit A] will reply to [Unit B] a message "SMS format is error!".
5. Again, [Unit B] receives the same message from [Unit A]. Since it will also consider this incoming text as a wrong command message, [Unit B] will reply to [Unit A] a message "SMS format is error!".
6. Such case will cause a serious "Dead Loop" problem.

Schematics of "Dead Loop" Problem

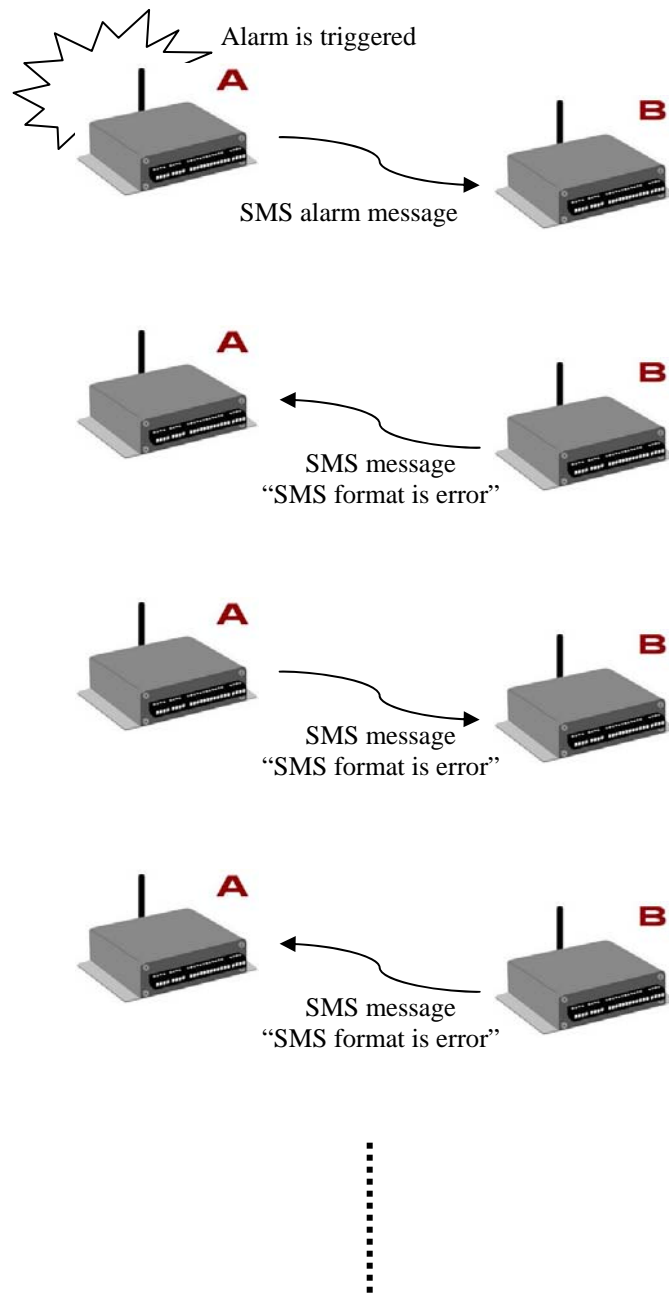

14. Power Loss & Resume

1) PWD:1234,ARM%

Above command is followed by another command e.g. PWD:XXXX,SN:YYY%
 ARM status will be kept when power is lost and resumed.

2) PWD:1234,ARM%

No other command is followed

DISARM status will be as default when power is lost and resumed.

15. Safety and Regulatory Notice

All applicable regulatory compliance statements, product certification markings, and safety and electromagnetic compatibility (EMC) standards and regulations the Data Logger is compliant with.

European Union Declaration of Conformity
Statement

We declare under our sole responsibility that the product GS828 GPRS Data Logger is in conformity with all applicable essential requirements necessary for CE marking, following the provisions of the European Council Directives 2004/108/EC (EMC Directive) and 2006/95/EC (Low Voltage Directive).



The product is properly CE marked demonstrating this conformity and is for distribution within all member states of the EU with no restrictions.

This product follows the provisions of the European Directives 2004/108/EC and 2006/95/EC.

16. Manufacturer's Disclaimer Statement

The information in this document is subject to change without notice and does not represent a commitment on the part of the vendor. No warranty or representation, either expressed or implied, is made with respect to the quality, accuracy or fitness for any particular purpose of this document. The manufacturer reserves the right to make changes to the content of this document and/or the products associated with it any time without obligation to notify any person or organization of such changes. In no event will the manufacturer be liable for direct, indirect, special, incidental or consequential damages arising out of the use or inability to use this product or documentation, even if advised of the possibility of such damages. This document contains materials protected by copyright. All rights are reserved. No part of this manual may be reproduced or transmitted in any form, by any means or for any purpose without expressed written consent of its authors. Product names appearing in this document are mentioned of identification purposes only. All trademarks, product names or brand names appearing in this document are registered property of their respective owners.